

sharonconnect.org



SHARON CONNECT

TASK FORCE

SHOULD SHARON BUILD ITS OWN HIGH-SPEED INTERNET NETWORK?

COMMUNITY MEETING • MARCH 31, 2022



What is the Sharon Connect Task Force?

A group of volunteers formed the task force in November 2019 to advise the Sharon Board of Selectmen on options to address the lack of universal access to high-speed internet. We sent a survey to residents in 2020 and more than 70% of the 551 households that responded said they would support the town building its own network to serve all homes and businesses. We set out to do research and understand the issues involved.

Sharon Connect Task Force Members

Jill Drew and Meghan Flanagan
co-chairs

John Brett	Patrick Gallaway	Roger Lourie	
Linda Neiberg	Ben Newhouse	Alexandra Peters	
Barbara Prindle	Brent Prindle	Beth Rybczyk	Eric Simon





Teaching from a Pickup

The Pecchia family lives on Lower Deer Run, a dirt road without high-speed internet access. When schools went to remote learning, David drove to the parking lot at JP Gifford's to teach all day from his pickup using the shop's free wifi.

Learning from a Lawn Chair

The Pecchia's daughters attended school from a lawn chair outside JP Gifford's. When it got too cold during the height of the pandemic, they huddled in the truck because patrons were not yet allowed to sit inside stores. Juliana Pecchia says, "JP's knew we were there and were very kind!"



Living with Frontier DSL

West Meadow Road

Number of devices connected to internet: 4
Download speeds: 2.12 - 5.18 Mbps

"We cannot run more than a tv with Netflix and a phone using our wifi without it buffering every 2 minutes. Using laptops and/or iPads uses too much, and our wifi cannot support it."



River Road

Number of devices connect to internet: 2
Download speeds: 24-26 Mbps

"I am a doctor connected to my office with difficulty."

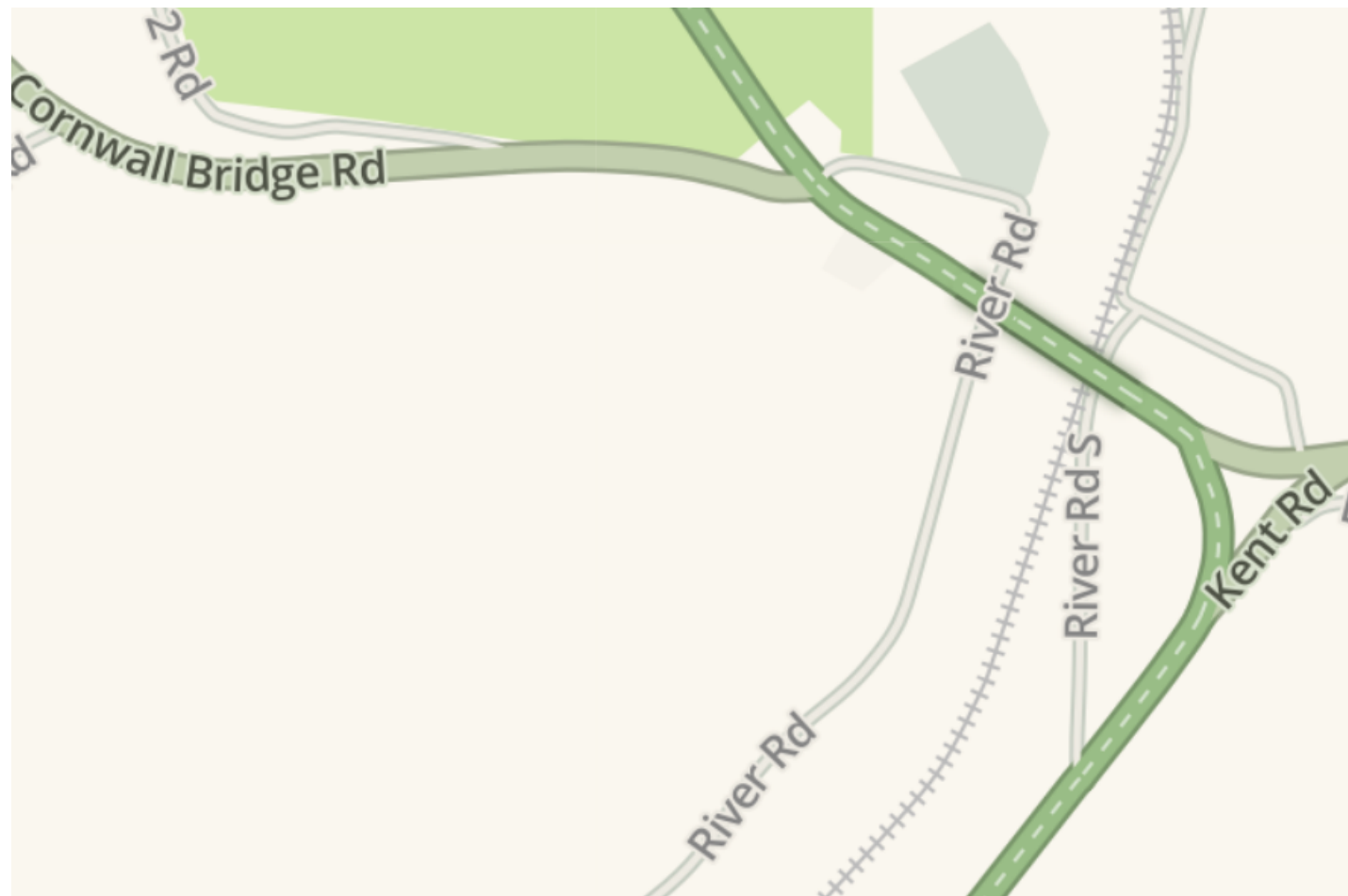
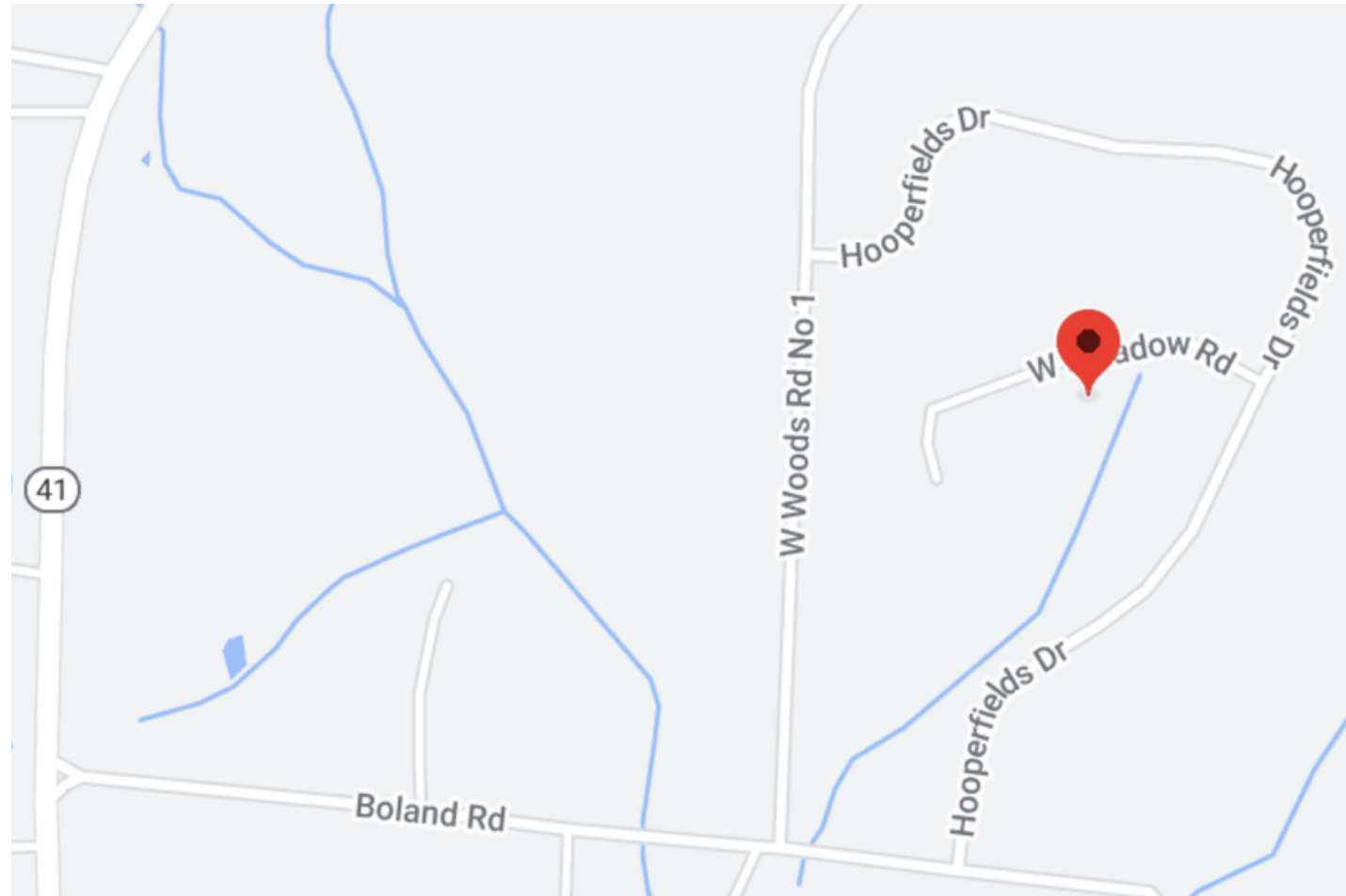

Late Night Data Runs

Jane Strong runs a nonprofit in Sharon that offers equine therapy for veterans. It has grown from 21 clients in 2013 to more than 1,500. As it has developed, so has Jane's need to exchange large files, videos, and presentations to reach veterans' organizations, sponsors and the facilitators in training who are bringing the program to other areas.

"When I have a file that is over 25 MB, I drive down to Gifford's, sit in my car and use their free wi-fi to download or send the files," Jane says. "Last year, I was there at 11pm on more than one occasion to get the files I needed for a presentation the next day."

Meanwhile, Jane's partner, John Brett, says this: "For the past 10 years, Jane and I have had to coordinate our turns online, and juggle zoom calls accordingly because we cannot run two separate calls simultaneously."





The Providers.

Comcast

More than 70% of Sharon residents subscribe to Comcast's internet service. Not all have access. It offers downloads as fast as 1.2 GB, but uploads are much slower. Its coaxial cable network is aging.

Frontier

Its Digital Subscriber Line Service (DSL) is often too slow to support streaming, video calls, or data uploads. The further a home is from Frontier's nearest node, the slower speeds get without a booster..

Satellite

Hughes Net satellite is not reliable and is used primarily as a last resort. Starlink has begun service to some but it has problems with video calls.

Cell Phones/Wifi Hotspots

Signals are too weak in many homes to support data transmission. Speeds degrade when many users sign on. Data caps can be costly.

Digital Divide: 240 Homes in Sharon Have No Access to Cable Internet



The Need.

- Before 2007, a cable provider was required by state law to build out 2 miles of road each year in its franchise area at no cost.
- The state legislature changed the law in 2007. Comcast has not built new network infrastructure in Sharon since then unless a homeowner or neighbors on a road band together to pay for it.
- Sharon Selectmen have tried for 15 years to get Comcast to wire the 27 miles of road in town with no high-speed cable internet.
- A year ago, the town asked Comcast what it would cost if the town chipped in funds to pay for wiring those roads. Comcast applied for a federal grant to do this, but it did not get it. It hasn't answered if it will work with the town to move forward.

Other Towns

- Cornwall, Goshen, and Litchfield are served by Altice Optimum, which is rewiring its network with fiber-optic lines to offer super-fast internet to its subscribers. This is its national strategy.
- Several towns in western Massachusetts have built fiber-to-the home networks using generous state subsidies. Some towns in NY are using state subsidies to build public-private fiber projects.
- The Town of Northeast (Millerton, NY) decided against pursuing a town-owned fiber network because spending money on improving its sewer system was deemed more urgent.
- Northwest ConneCT is pursuing a regional approach trying to engage both Frontier and Google Fiber.



Try to Work With Comcast

It has said it would work with the town, but has not made a proposal. If it does agree to build out, it will continue to own and control the network.

Find a New Provider

This will be hard. With an average of 15 homes per mile, we are too spread out for a business to make enough profit to build here.

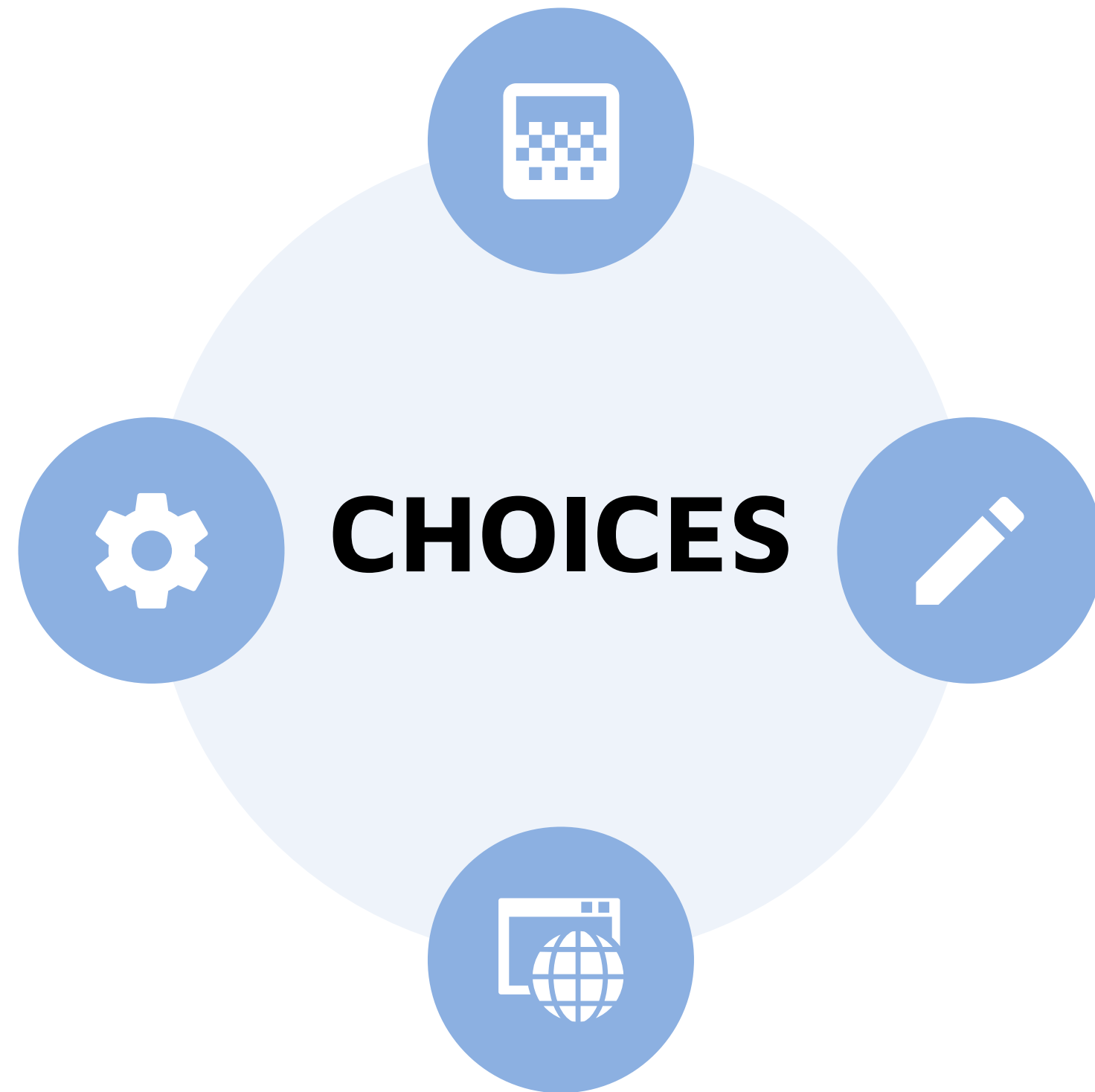

Do Nothing and Wait

Many of our neighbors will remain stuck with inadequate service. It will be difficult to keep residents and attract new families or businesses.

Build a New Network for All

The town could take charge of its future and build a network that it would own. It would prioritize serving all residents at the lowest cost.



The town of Sharon last fall hired Sertex Broadband Solutions to develop an initial engineering design and business plan for a town-owned fiber-optic network that offers access to high-speed internet for every home and business.

Sertex completed its feasibility analysis earlier this year. The following slides are based on that report.



The Network.



Why Do We Need Speed?

The pandemic lockdown was a wake-up call for those forced to work or attend school online. Suddenly multiple family members with multiple devices needed stable connections at the same time. Telemedicine, home security and other uses all demand high speed.

Why Fiber?

A single strand of fiber has thousands of times the capacity of any other wired or wireless medium. Fiber does not corrode so it is less expensive to maintain and lasts for decades. Technologists call it "future proof."



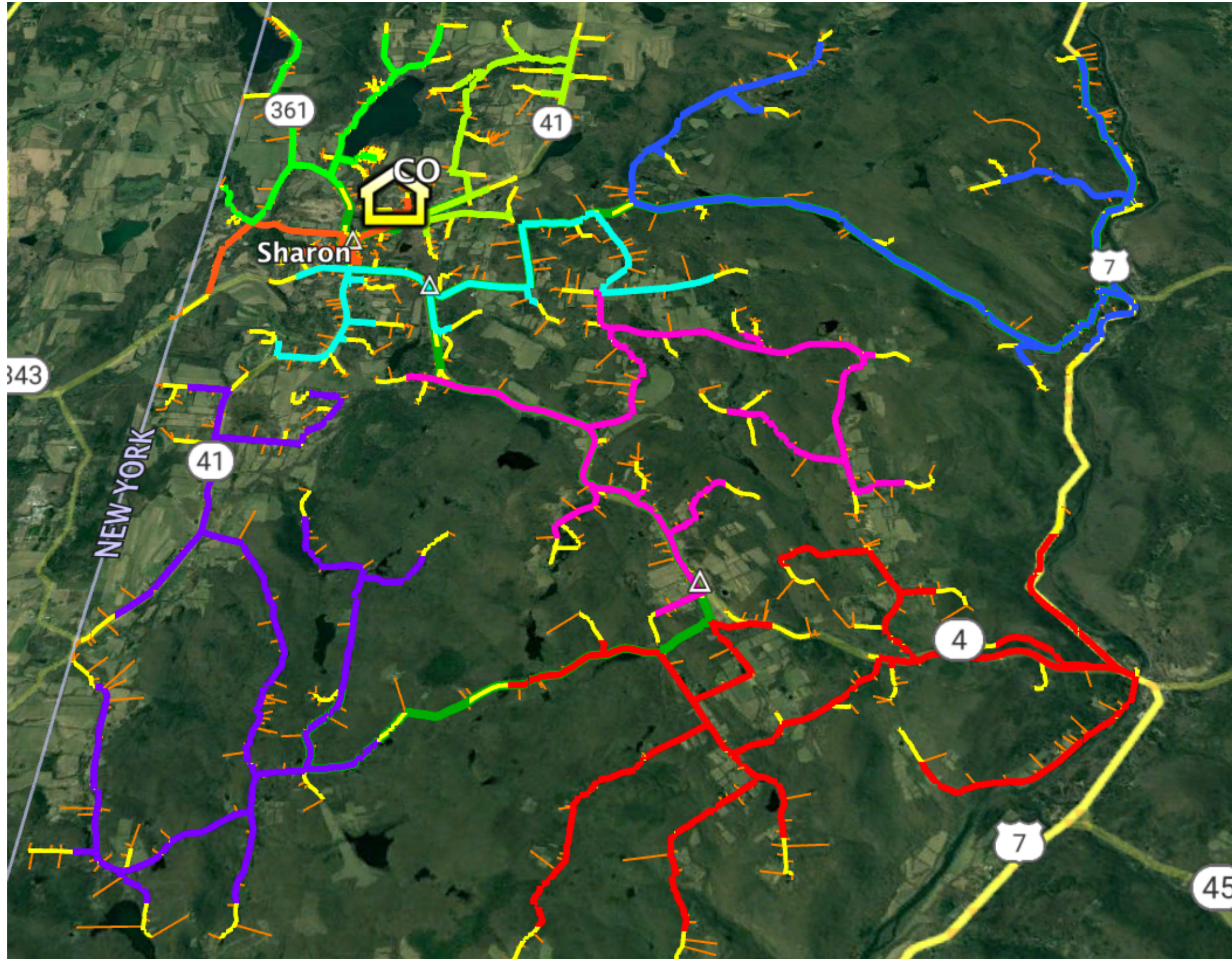

Network Details.

Total Route Mileage - 117 miles

Aerial Route - 104 miles

Underground Route - 13 miles

Total Number of Homes - 1,749

Avg Homes per mile - 15

Avg Cost per mile - \$87,426

Avg Cost per home - \$5,846

(colors indicate different fiber service areas)

A Fiber-To-The-Premises Network

This Gigabit Passive Optical Network (GPON) uses shared equipment at a headend building - possibly located at Sharon Center School. That equipment links the local network to the larger internet. Fiber optic lines run from the headend to distribution hubs, then to service terminals, and then to each premises, where there is a dedicated optical unit at each subscriber location. All subscribers would be served with 1GB download and upload speeds.

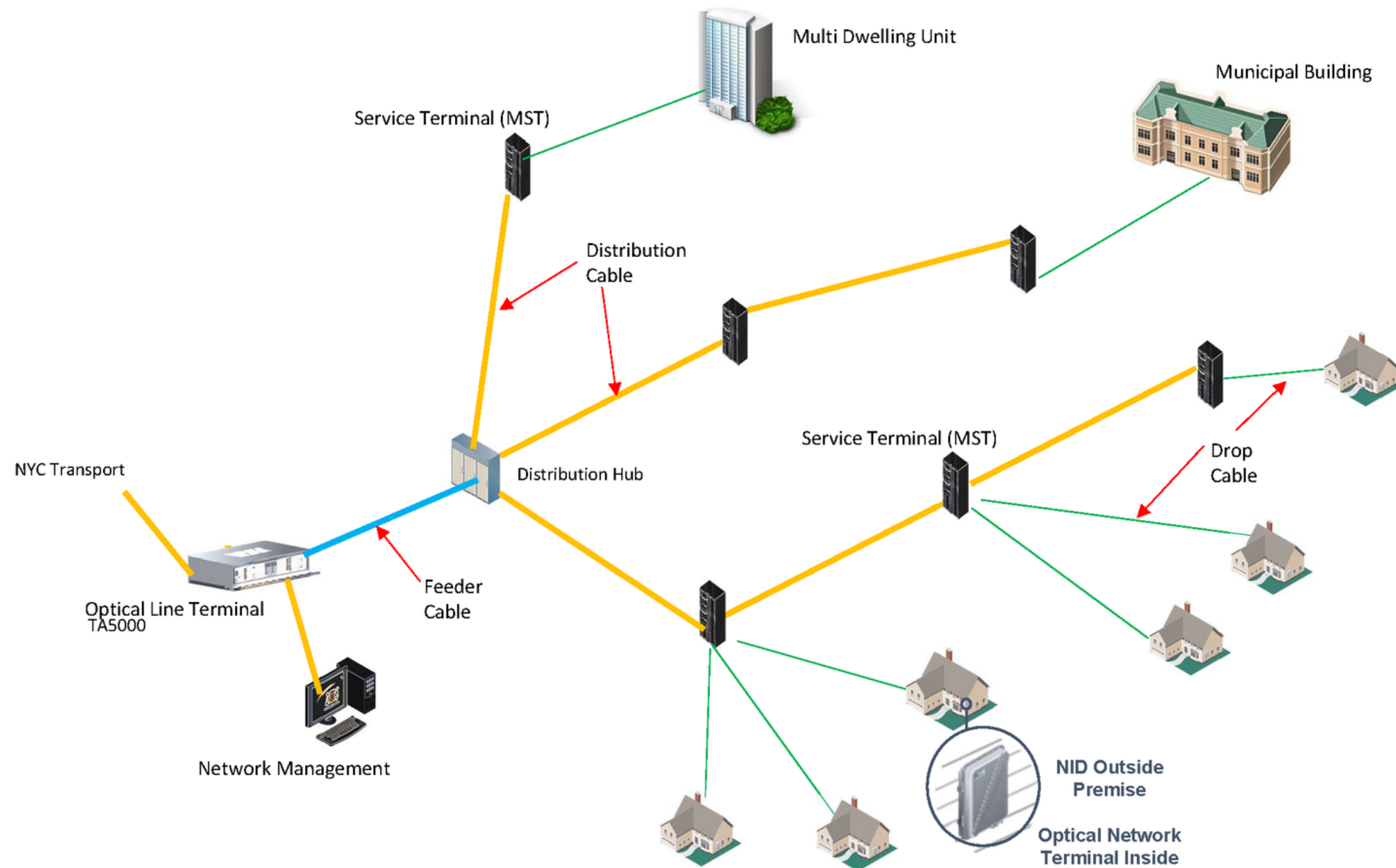

Standard Broadband Drop Configuration for Single Family Home

Step 1

Outdoor Construction

- One dedicated **underground *or* aerial** single-fiber service drop cable provided per property
- One **Network Interface Device (NID)**

Step 2

Indoor Service Installation

- One **Optical Network Terminal (ONT)** includes:
 - A** Fiber Optic connector cable up to 50 feet
 - B** ONT with Li-Ion battery backup
 - C** Cat6 data cable connecting ONT to router
 - D** Wireless Router

Step 3

Indoor Components

- **Customer is responsible** for any additional costs for nonstandard or complex installations, and multiple data cables
- **UPS/Surge protection is recommended** for customer computer and communication equipment

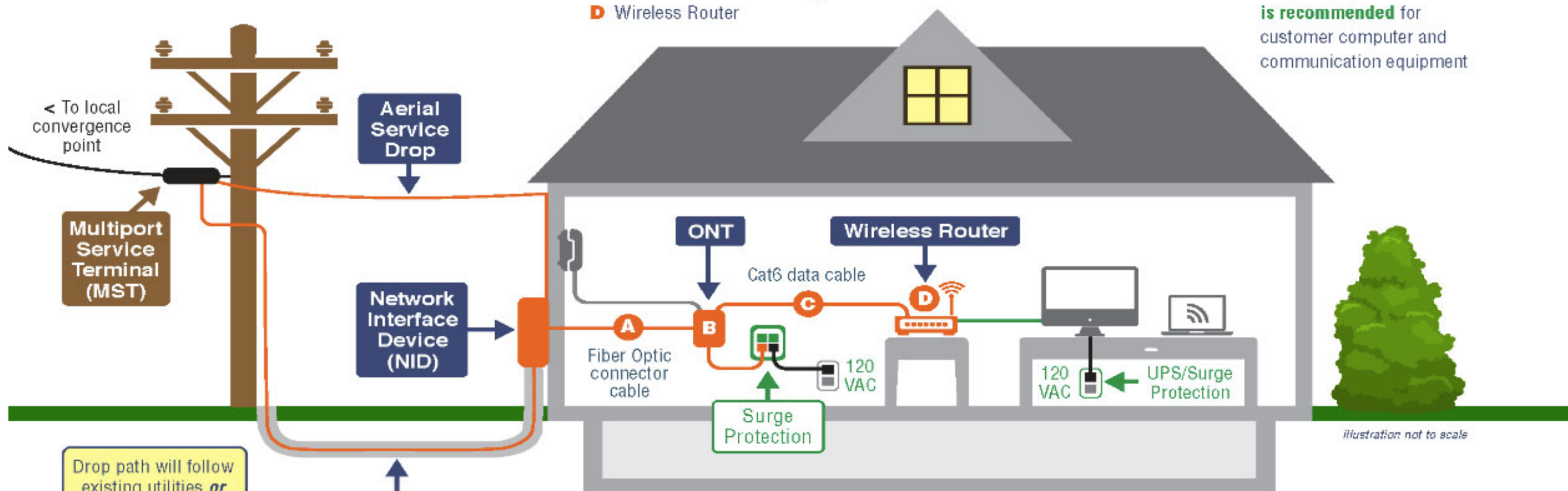

Drop path will follow existing utilities *or* most efficient route

Underground Service Drop

Installed in new *or* existing conduit. Additional charges may apply for non-standard installations

Glossary

Multiport Service Terminal (MST) – provides multiple fiber tap ports for service drop connections

Network Interface Device (NID) – junction box installed outdoors

Optical Network Terminal (ONT) – transceiver device that converts between electrical and optical signals at the customer premises

Cat6 – Category 6 cable that uses 4 unshielded, twisted-pair wires to carry up to 1 Gbps data signals up to 100 meters

Li-Ion Battery – provides up to 8 hrs of power backup to the ONT

Uninterrupted Power Supply (UPS) – a device that provides short-term backup electrical power for connected devices



The Cost.

Cost to Subscribe - Residents

- \$89/month for 1GB download and upload speeds
- No fee for a standard installation; equipment provided
- Internet phone service is an extra \$20/month
- No linear tv service offered, but plenty of options for internet tv
- If you live 500+ feet from a road, extra costs to be considered

Cost to Build - the Town

- \$12.5 million for construction and initial set up
- 24-30 months for construction phase
- Town sells 40-year bonds to finance project
- Property taxes could rise as much as 0.7 mill, or \$70 for every \$100,000 of property, to pay bond principal and interest
- The Board of Selectmen and Board of Finance have the final say on how to finance the network

Cost to Operate and Maintain - Subscription Fees

Like Sharon's Sewer & Water Commission, Sharon Connect's fiber internet network would pay for ongoing operating and maintenance expenses from user subscription fees. For those costs to be covered, the network would have to meet a high enough "take rate," the percentage of households that subscribe. If 33% of the households in Sharon subscribe to the town-owned network, all operating costs will be covered.

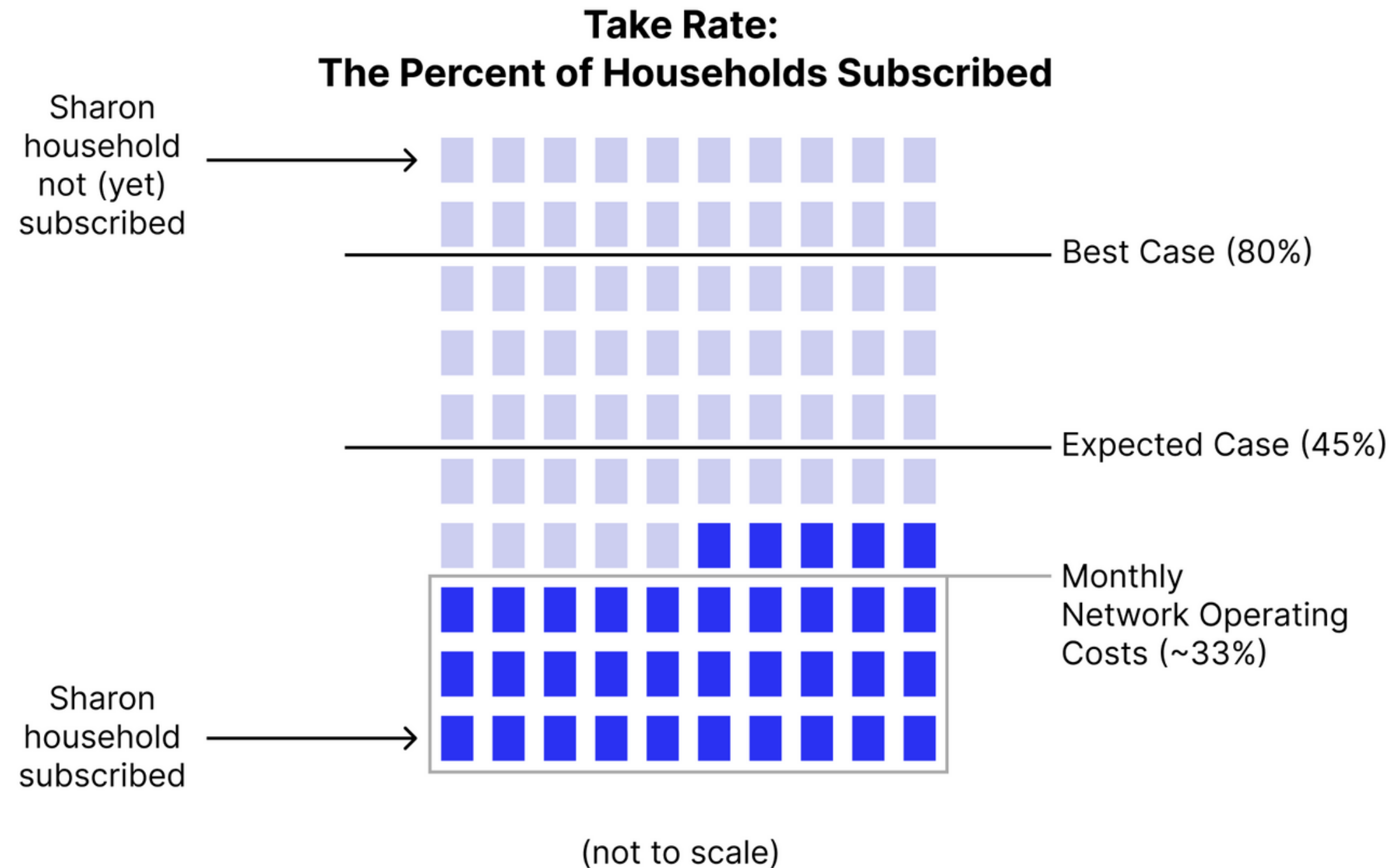

Could Sharon Qualify for State or Federal Grants?

- Connecticut has \$20 million set aside now for high-speed internet projects. Another \$14 million is proposed in the Governor's budget
- Another \$100 million in federal funding is coming to the state, likely in 2022 or 2023
- We aren't counting on grants, but will apply

What About Those Who Cannot Afford Internet?

- Sharon has a poverty rate above 11%
- Many seniors live on a fixed income
- Sharon Connect will press for subsidies and help residents with federal aid available
- We would also like to offer free service to volunteer first responders



Sertex Outlines the Benefits of a Town-Owned Network

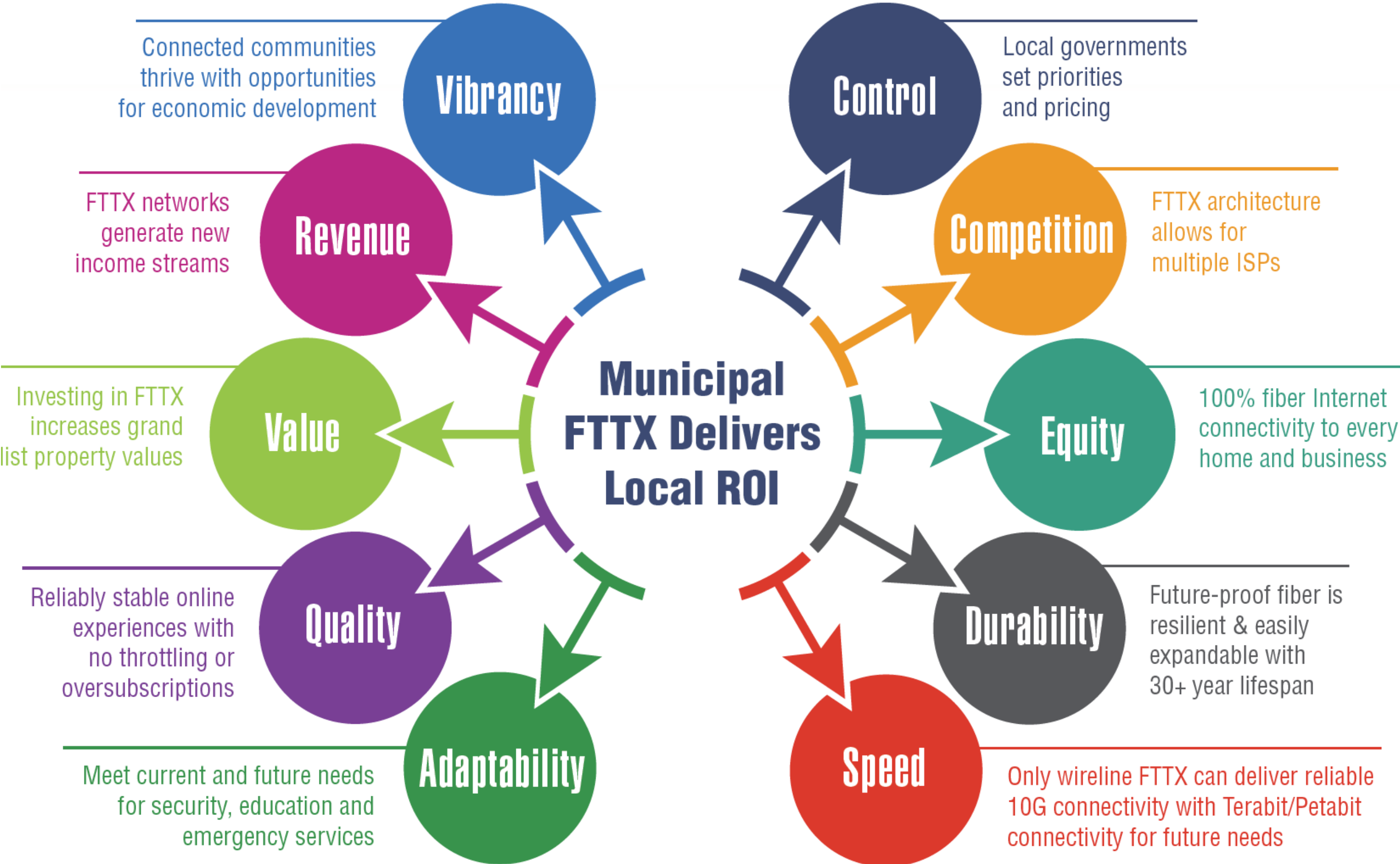



A Few Questions.

Isn't Starlink going to come and make this all obsolete?

While Starlink is a massive improvement over existing satellite providers like Hughesnet, it is not competitive with fiber in terms of performance. Typical speeds in Sharon are on the order of 100mb down and 10mb up for \$100/mo with occasional seconds-long outages that make video conferencing tricky. Starlink recently announced a tier with double these speeds, but it's a wild \$500/mo! (Note recent price increase)

Isn't 5G going to come and make this all obsolete?

5G is fundamentally a wireless standard and generally speaking you need something pretty close to a line of sight to receive a good wireless signal. Given Sharon's terrain, we would need additional cell towers to meaningfully improve cell service. Getting those built poses the same challenges that we have getting other private companies like Comcast to invest in our local infrastructure.

I'm worried about all of this new technology, Given all of the concerns about 5G, how do we know fiber is safe?

Unlike 5G, which has only begun rolling out in the past couple of years, fiber has been used in telecom backbones since the 80s and fiber networks were first deployed to the home in the early 2000s. Fiber lines use light, not radio waves or electricity, to transmit data.

Why should everyone in the town pay for this if it's only going to benefit a few people who don't have internet? I'm happy with my internet.

In the same way that not everyone uses every road in town or how we all contribute to the schools via property taxes even if we don't have young children, this would be a shared investment that ensures access for everyone regardless of socioeconomic status. And this question is precisely why we're having this discussion today: so that we can all collectively decide whether this investment makes sense.

The town only has so much money to spend & borrow. If we do this, what other budget priorities are at risk?

Good question. We need to look at the town's five-year capital spending plan. Improving connectivity is one of the items in the plan, but there are many priorities. The Board of Selectmen and Board of Finance will have the final say on what plan, if any, is presented for a vote at a Town Meeting.



More Questions.



HOW TO MOVE FORWARD?

—
**Help us decide.
Take our poll.**



THANK YOU

—
Go to

sharonconnect.org

for more details or email us at

sharonctconnect@gmail.com